

HL BUTTERFLY VALVE WITH GEAR ACTUATOR

SPECIFICATIONS:

Sizes:	10" to 24"
Materials:	PVC/PP, CPVC (Corzan) PVDF/PVDF, PVC/PVDF
Seals	EPDM, Viton or Buna
Connections:	ANSI 150 Flanged
Pressure Rating:	see chart

Applications:

- Water and wastewater treatment
- Contaminated and aggressive fluids
- Chemical industry
- Process technology
- Environmental technology
- Systems engineering



Sample Specifications:

All Praher Butterfly valves are constructed of the materials indicated above. Shaft shall be stainless steel, run through entire disc and be removeable and replaceable independently of the disc.

Shaft shall be protected by a double seal arrangement on top and bottom of the disc.

Each double seal arrangement will feature a dynamic seal o-ring and static seal (integrally molded on the liner).

Liner shall be molded and contoured through the entire body and face on the valve to act as a flange liner gasket. Liner and disc shall be the only wetted parts. Butterfly valves must be of bubble tight and of flange design as specified by Praher.

Special Features:

- Ideally suited to control flow in tight spaces
- Disc design for small head loss
- Easy view position indicator
- Non wetted stem design
- Gear operators on all sizes
- Lugs available
- Electric or pneumatic actuation and stem extensions available

K4 Butterfly Valve – Cv Value

10" (DN200)	3850
12" (DN300)	5680
14" (DN350)	6400
16" (DN400)	8300
18" (DN450)	10800
20" (DN500)	14500
24" (DN600)	18500

Pressure-Temperature rating: PSI/Fahrenheit

	Seat/seal	temp	10	12	14	16	18	20	24
PVC	EPDM/VITON	70F	150	100	100	86	75	75	75
BODY	EPDM/VITON	120F	100	60	45	45	45	45	45
PP	EPDM/VITON	140F	30	30	30	30	30	30	30
DISC	EPDM/VITON	180F	15	15	N/A	N/A	N/A	N/A	N/A
PVDF	VITON	70F	150	100	100	82	70	50	50
body	VITON	150F	100	60	45	45	45	30	30
PVDF	VITON	210F	80	40	30	30	30	20	20
disc	VITON	250F	60	20	15	15	15	15	15

HL BUTTERFLY VALVE WITH GEAR ACTUATOR

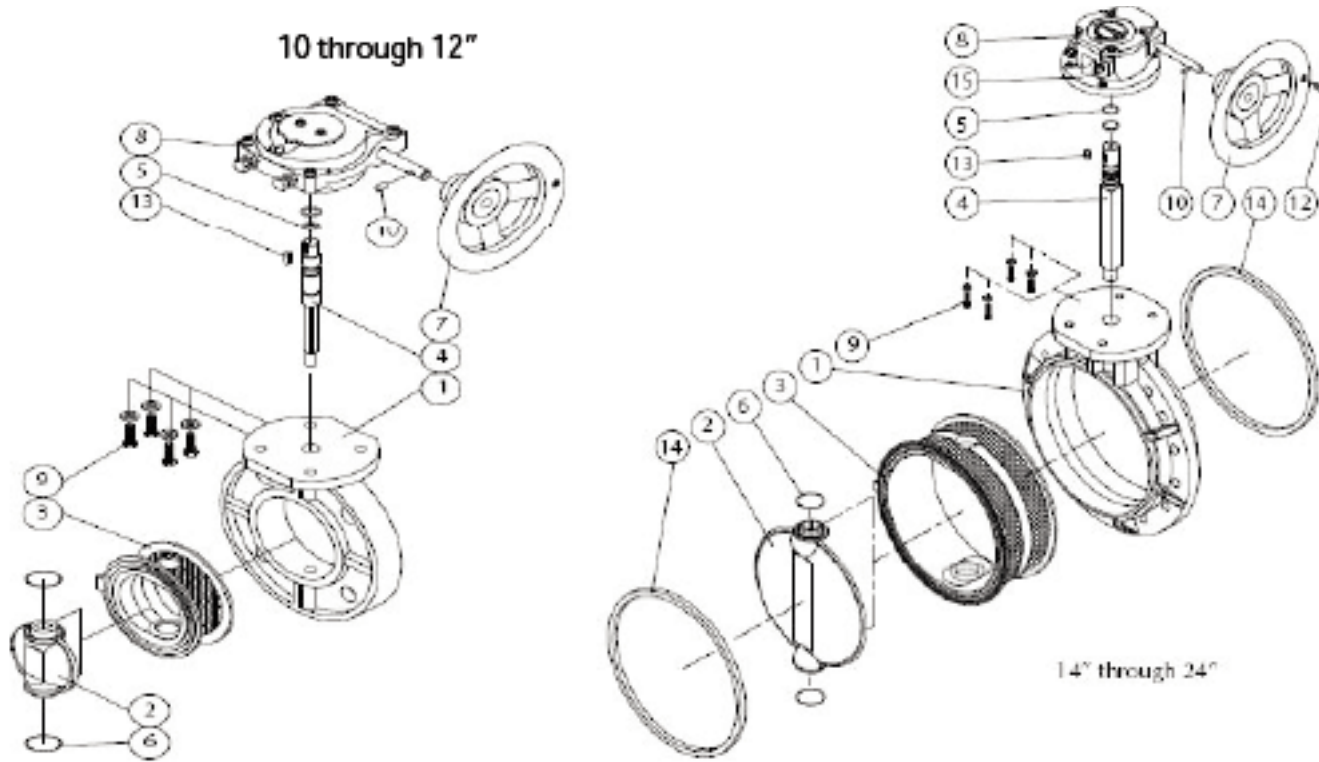

Number	Description	Material	Qty.
1	Body	PVC, CPVC, PP, PVDF	1
2	Disc	PVC, CPVC, PP, PVDF	1
3	Seat Seal	EPDM, Viton	1
4	Stem	Stainless Steel - 410	1
5	O-Ring	EPDM, Viton	2
6	O-Ring	EPDM, Viton	2
7	Hand Wheel	FC- Cast Iron (Epoxy)	1
8	Gear Box	FC- Cast Iron (Epoxy)	1
9	Bolt & Washer	Stainless Steel - 304	4
10	Spring Pin	Stainless Steel - 41	1
11	Packing	EPDM	1
12	Small Handle	Stainless Steel - 304	1
13	Key	Stainless Steel - 45C	1
14	Seal	Stainless Steel - 304	2
15	Metal Stat	Stainless Steel - 41	1
15	Insert Nut	C3604	4

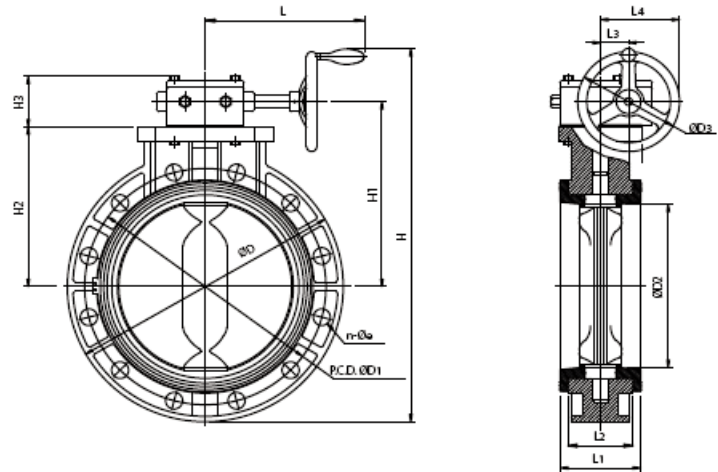

Dimensional Data:

d Inches	Gear Operated													# of Holes	Hole Size
	D	D1	D2	D3	H	H1	H2	H3	L	L1	L2	L3	L4		
10"	16.18	14.25	10.04	7.87	23.23	11.02	9.45	2.99	10.94	4.33	3.76	2.24	6.18	12	0.98
12"	19.29	17.01	12.24	9.84	28.03	13.27	11.69	2.99	12.99	5.20	4.59	2.36	7.28	12	0.98
14"	20.87	18.74	13.98	9.84	28.74	13.39	11.81	2.99	12.99	5.00	4.45	2.36	7.28	12	1.14
16"	23.62	21.28	15.51	11.81	34.45	16.73	13.78	4.72	13.90	6.61	6.02	3.19	9.09	12	1.14
18"	25.00	22.76	17.80	11.81	34.88	16.46	14.57	4.33	10.83	7.05	6.42	5.31	11.22	16	1.26
20"	27.52	25.00	19.78	15.75	39.29	17.64	15.75	5.24	13.76	7.48	6.73	5.31	13.19	20	1.26
24"	32.01	29.49	23.74	15.75	44.09	20.20	18.31	5.24	13.76	8.23	7.52	5.31	13.19	20	1.38